

KENWOOD

NEXEDGE

NX-720 NX-720G

NX-820 NX-820G

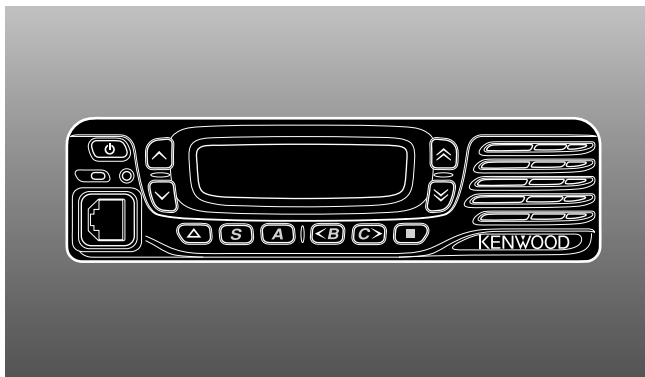

VHF DIGITAL TRANSCEIVER
UHF DIGITAL TRANSCEIVER

INSTRUCTION MANUAL

ÉMETTEUR-RÉCEPTEUR NUMÉRIQUE VHF
ÉMETTEUR-RÉCEPTEUR NUMÉRIQUE UHF

MODE D'EMPLOI

TRANSCÉPTOR DIGITAL VHF
TRANSCÉPTOR DIGITAL UHF

MANUAL DE INSTRUCCIONES

RICETRASMETTITOR E DIGITAL E VHF
RICETRASMETTITOR E DIGITAL E UHF

MANUALE DI ISTRUZIONI

VHF DIGITAL FUNKGERÄT
UHF DIGITAL FUNKGERÄT

BEDIENUNGSANLEITUNG

VHF DIGITAL E ZENDONTVANGER
UHF DIGITAL E ZENDONTVANGER

GEBRUIKSAANWIJZING

VHF SAYISAL ARAÇ TELSİZİ
UHF SAYISAL ARAÇ TELSİZİ

KULLANIM KILAVUZU

ΨΗΦΙΑΚΟΣ ΠΟΜΠΟΔΕΚΤΗΣ VHF
ΨΗΦΙΑΚΟΣ ΠΟΜΠΟΔΕΚΤΗΣ UHF

ΟΔΗΓΙΕΣ ΧΡΗΣΗΣ

JVC KENWOOD Corporation

© B62-2447-10 (E)
09 08 07 06 05 04 03 02 01

VHF DIGITAL TRANSCEIVER
UHF DIGITAL TRANSCEIVER

NX-720 NX-720G
NX-820 NX-820G

INSTRUCTION MANUAL

JVCKENWOOD Corporation

ENGLISH

NOTIFICATION

This equipment complies with the essential requirements of Directive 1999/5/EC.

The use of the warning symbol ⓘ means the equipment is subject to restrictions of use in certain countries.

This equipment requires a licence and is intended for use in the countries as below.

AT	BE	DK	FI	FR	DE	GR	IS
IE	IT	LI	LU	NL	NO	PT	ES
SE	CH	GB	CY	CZ	EE	HU	LV
LT	MT	PL	SK	SI	BG	RO	

THANK YOU

We are grateful you have chosen **KENWOOD** for your personal mobile applications.

This instruction manual covers only the basic operations of your mobile radio. Ask your dealer for information on any customized features they may have added to your radio.

NOTICES TO THE USER

- ◆ Government law prohibits the operation of unlicensed transmitters within the territories under government control.
- ◆ Illegal operation is punishable by fine and/or imprisonment.
- ◆ Refer service to qualified technicians only.

SAFETY: It is important that the operator is aware of, and understands, hazards common to the operation of any transceiver.



WARNING

- ◆ **EXPLOSIVE ATMOSPHERES (GASES, DUST, FUMES, etc.)**
Turn OFF your transceiver while taking on fuel or while parked in gasoline service stations. Do not carry spare fuel containers in the trunk of your vehicle if your transceiver is mounted in the trunk area.
- ◆ **INJURY FROM RADIO FREQUENCY TRANSMISSIONS**
Do not operate your transceiver when somebody is either standing near to or touching the antenna, to avoid the possibility of radio frequency burns or related physical injury.
- ◆ **DYNAMITE BLASTING CAPS**
Operating the transceiver within 500 feet (150 m) of dynamite blasting caps may cause them to explode. Turn OFF your transceiver when in an area where blasting is in progress, or where "TURN OFF TWO-WAY RADIO" signs have been posted. If you are transporting blasting caps in your vehicle, make sure they are carried in a closed metal box with a padded interior. Do not transmit while the caps are being placed into or removed from the container.

Information on Disposal of Old Electrical and Electronic Equipment and Batteries (applicable for countries that have adopted separate waste collection systems)



Products and batteries with the symbol (crossed-out wheeled bin) cannot be disposed as household waste.

Old electrical and electronic equipment and batteries should be recycled at a facility capable of handling these items and their waste byproducts.



Contact your local authority for details in locating a recycle facility nearest to you.

Proper recycling and waste disposal will help conserve resources whilst preventing detrimental effects on our health and the environment.



Notice: The sign "Pb" below the symbol for batteries indicates that this battery contains lead.

Pb

PRECAUTIONS

Observe the following precautions to prevent fire, personal injury, and transceiver damage.

- Do not attempt to configure the transceiver while driving; it is too dangerous.
- Do not disassemble or modify the transceiver for any reason.
- Do not expose the transceiver to long periods of direct sunlight, nor place it near heating appliances.
- If an abnormal odor or smoke is detected coming from the transceiver, switch the transceiver power off immediately, and contact your **KENWOOD** dealer.
- Use of the transceiver while you are driving may be against traffic laws. Please check and observe the vehicle regulations in your area.
- Do not use options not specified by **KENWOOD**.



CAUTION

- ◆ The transceiver operates in 12 V negative ground systems only! Check the battery polarity and voltage of the vehicle before installing the transceiver.
- ◆ Use only the supplied DC power cable or a **KENWOOD** optional DC power cable.
- ◆ Do not cut and/or remove the fuse holder on the DC power cable.



WARNING

For passenger safety, install the transceiver securely using the supplied mounting bracket and screw set so the transceiver will not break loose in the event of a collision.

CONTENTS

GETTING STARTED.....	1
GETTING ACQUAINTED.....	3
PROGRAMMABLE FUNCTIONS.....	5
BASIC OPERATIONS.....	6
SCAN	8
FleetSync: ALPHANUMERIC 2-WAY PAGING FUNCTION.....	10
5-TONE SIGNALING	12
DTMF CALLS.....	13
ADVANCED OPERATIONS	15
BACKGROUND OPERATIONS	19

GETTING STARTED

Note: The following instructions are for use by your **KENWOOD** dealer, an authorized **KENWOOD** service facility, or the factory.

SUPPLIED ACCESSORIES

Carefully unpack the transceiver. We recommend that you identify the items listed below before discarding the packing material. If any items are missing or have been damaged during shipment, file a claim with the carrier immediately.

DC power cable (with fuses)	1
• 15 A fuse	2
Mounting Bracket	1
Screw set	
• 5 x 16 mm self-tapping screw	4
• M4 x 6 mm hex-headed screw with washer	4
• Spring washer	4
• Flat washer	4
Instruction manual	1

PREPARATION



WARNING

Various electronic equipment in your vehicle may malfunction if they are not properly protected from the radio frequency energy which is present while transmitting. Typical examples include electronic fuel injection, anti-skid braking, and cruise control. If your vehicle contains such equipment, consult the dealer for the make of vehicle and enlist his/her aid in determining if they will perform normally while transmitting.

■ Power Cable Connection



CAUTION

The transceiver operates in 12 V negative ground systems only! Check the battery polarity and voltage of the vehicle before installing the transceiver.

- 1 Check for an existing hole, conveniently located in the firewall, where the power cable can be passed through.
 - If no hole exists, use a circle cutter to drill a hole, then install a rubber grommet.
- 2 Run the power cable through the firewall and into the engine compartment.
- 3 Connect the red lead to the positive (+) battery terminal and the black lead to the negative (-) battery terminal.
 - Place the fuse as close to the battery as possible.
- 4 Coil the surplus cable and secure it with a retaining band.
 - Be sure to leave enough slack in the cables so the transceiver can be removed for servicing while keeping the power applied.

■ Installing the Transceiver



For passenger safety, install the transceiver securely using the supplied mounting bracket and screw set, so the transceiver will not break loose in the event of a collision.

Note: Before installing the transceiver, check how far the mounting screws will extend below the surface. When drilling mounting holes, be careful not to damage vehicle wiring or parts.

- 1 Mark the position of the holes in the dash, using the mounting bracket as a template. Using a 4.2 mm (5/32 inch) drill bit, drill the holes, then attach the mounting bracket using the supplied screws.
 - Mount the transceiver within easy reach of the user and where there is sufficient space at the rear of the transceiver for cable connections.
- 2 Connect the antenna and the supplied power cable to the transceiver.
- 3 Slide the transceiver into the mounting bracket and secure it using the supplied hex-headed screws.
- 4 Mount the microphone hanger in a location where it will be within easy reach of the user.
 - The microphone and microphone cable should be mounted in a place where they will not interfere with the safe operation of the vehicle.



When replacing the fuse in the DC power cable, be sure to replace it with a fuse of the same value. Never replace a fuse with one that is rated with a higher value.

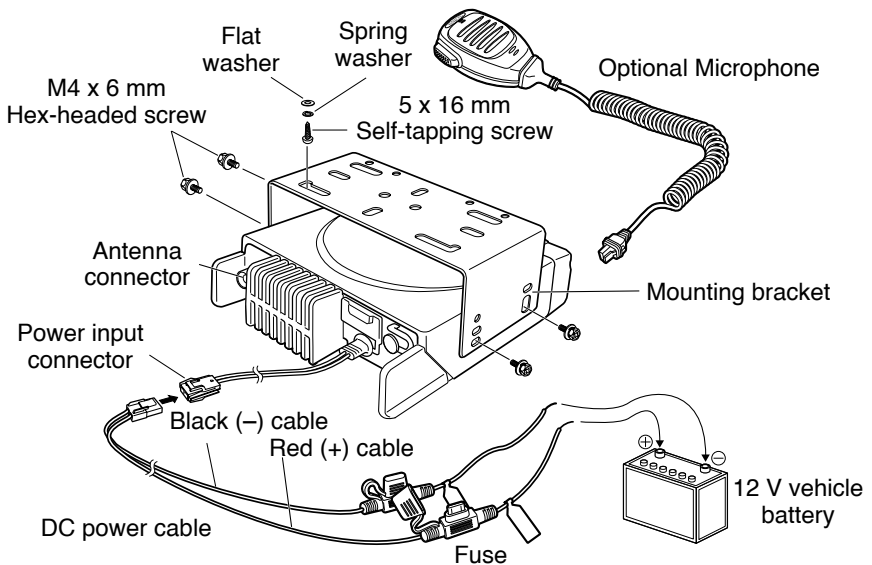

GETTING ACQUAINTED

FRONT AND REAR VIEWS

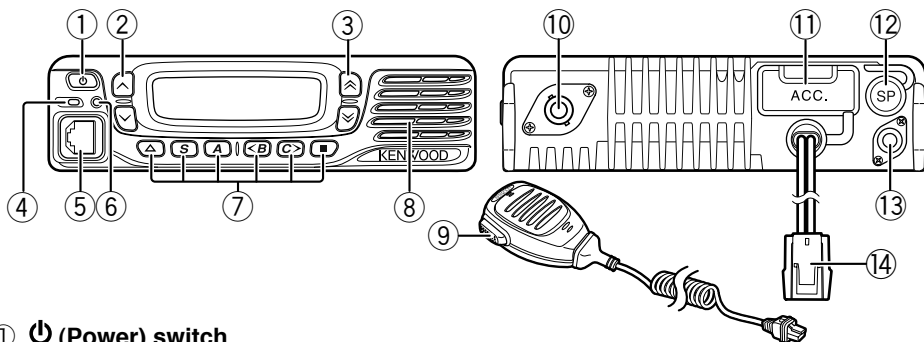

- ① **⏻ (Power) switch**
Press to switch the transceiver ON or OFF.
- ② **^ / v keys**
Press to activate their programmable functions {page 5}.
- ③ **⧗ / ⧘ keys**
Press to activate their programmable functions {page 5}.
- ④ **TX/RX Indicator**
Lights red while transmitting and green while receiving a signal. Flashes orange when receiving an optional signaling call.
- ⑤ **Microphone jack**
Insert the microphone plug into this jack.
- ⑥ **Status Indicator**
Lights blue during a specified mode, based on dealer programming.
- ⑦ **Δ / S / A / <B / C> / ■ keys**
Press to activate their programmable functions {page 5}.
- ⑧ **Speaker**
Internal speaker.
- ⑨ **PTT switch**
Press this switch, then speak into the microphone to call a station.
- ⑩ **RF antenna connector**
Connect the RF antenna to this connector.
- ⑪ **ACC connector**
Connect the ACC to this connector, via the KCT-60.
- ⑫ **External speaker jack**
Connect an external speaker to this jack.
- ⑬ **GPS antenna connector <NX-720G/ NX-820G only>**
Connect the KRA-40 GPS antenna to this connector.
- ⑭ **Power input connector**
Connect the DC Power Cable to this connector.

DISPLAY

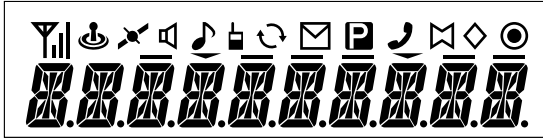

Icon	Description
	Displays the signal strength.
	Not used.
	Appears when the GPS position is determined.
	Appears when Monitor or Squelch Off is activated.
	Blinks when an incoming call matches your Optional Signaling.
	Appears when the Talk Around function is on.
	Lights while scanning or while paused on a channel. Blinks when scan is temporarily stopped.
	Lights when a caller message is in the stack memory. Blinks when the new message is in the stack memory.
	The selected channel is the Priority channel.
	Not used.
	The Scrambler/ Encryption function is on.
	The Public Address function is on.
	Not used.
	The current zone is added to the scan sequence.
	The External Speaker function is on.
	The AUX A function is on.
	The AUX B function is on.
	The current Channel/Group ID is added to the scan sequence.
	The Operator Selectable Tone function is on.
	Not used.

PROGRAMMABLE FUNCTIONS

The \wedge , \vee , $\hat{\wedge}$, $\hat{\vee}$, \blacktriangle , **S**, **A**, **<B**, **C>**, and \blacksquare keys can be programmed with the functions listed below. Ask your dealer for details on these functions.

- None
- Autodial
- Autodial Programming
- AUX A
- AUX B
- Broadcast ¹
- Call 1 ~ 6
- CH/GID Down
- CH/GID Recall
- CH/GID Up
- Channel Entry
- CW Message ²
- Digit 1 x Down ³
- Digit 10 x Down ³
- Digit 1 x Up ³
- Digit 10 x Up ³
- Direct CH/GID 1 ~ 5
- Display Format
- Emergency ⁴
- External Speaker
- Fixed Volume
- Forced Search ¹
- Function
- GPS Position Display
- Group ID/Channel Entry
- Group ⁵
- Group + Short Message ⁵
- Group + Status ⁵
- Home CH/GID
- Horn Alert
- Individual ⁵
- Individual + Short Message ⁵
- Individual + Status ⁵
- LCD Brightness
- Lone Worker
- Maintenance
- Monitor ⁶
- Monitor Momentary ⁶
- Operator Selectable Tone ³
- Priority-channel Select ⁷
- Public Address
- Receive Entry ²
- Scan
- Scan Delete/Add
- Scrambler/ Encryption
- Scrambler/ Encryption Code
- Selcall ⁸
- Selcall + Short Message ⁸
- Selcall + Status ⁸
- Send the GPS data
- Short Message
- Site Down ¹
- Site Lock ¹
- Site Up ¹
- Squelch Level ³
- Squelch Off ³
- Squelch Off Momentary ³
- Stack
- Status
- Talk Around ⁸
- Transfer ³
- Transceiver Password
- Volume Down
- Volume Up
- Zone Delete/Add
- Zone Down
- Zone Up

¹ Available only for NXDN Trunking operation.

² Available only for NXDN Conventional operation.

³ Available only for Analog Conventional operation.

⁴ Emergency can be programmed only on the \blacktriangle key. When assigned, the dealer must set the key assignment hold to "Enable" and second function as "Emergency".

⁵ Available only for NXDN Conventional operation and NXDN Trunking operation.

⁶ Available only for Analog Conventional, Analog Trunking, and NXDN Conventional operation.

⁷ Available only for Analog Conventional and NXDN Conventional operation.

⁸ Available only for Analog Conventional and Analog Trunking operation.

BASIC OPERATIONS

SWITCHING POWER ON/ OFF



Press  to switch the transceiver ON.

- A beep sounds and the display illuminates.
- If the Transceiver Password function is programmed, "PASSWORD" will appear on the display.

Press  again to switch the transceiver OFF.

■ Transceiver Password

To enter the password:

- 1 Press the  key to select a digit.
 - When using a microphone DTMF keypad, simply enter the password digits and proceed to step 4.
- 2 Press the **S** or  key to accept the entry and move to the next digit.
 - Press the **A** or **#** key to delete an incorrect digit.
 - Press the **C>** key to delete all.
- 3 Repeat steps 1 and 2 to enter the entire password.
 - The password can contain a maximum of 6 digits.
- 4 Press the **S** or  key to confirm the entered password.
 - If you enter an incorrect password, an error tone sounds and the transceiver remains locked.

ADJUSTING THE VOLUME

Press the **[Volume Up]** key to increase the volume. Press the **[Volume Down]** key to decrease the volume.

If Squelch Off has been programmed onto a key, you can use that function to listen to background noise while adjusting the volume level.

SELECTING A ZONE AND CHANNEL/GROUP ID

Select the desired zone and channel/group ID using the keys programmed as **[Zone Up]/ [Zone Down]** and **[CH/GID Up]/ [CH/GID Down]**.

- You can program names for zones and channels/group IDs with up to 10 characters.
- If the Voice Announce function has been set up by your dealer, an audio voice will announce the new zone, channel and group number when changing the zone, channel, and/or group.

TRANSMITTING

- 1 Select the desired zone and channel/group ID.
- 2 Press the key programmed as **[Monitor]** or **[Squelch Off]** to check whether or not the channel is free.

- If the channel is busy, wait until it becomes free.
- 3** Press the **PTT** switch and speak into the microphone. Release the **PTT** switch to receive.
- For best sound quality, hold the transceiver approximately 1.5 inches (3 ~ 4 cm) from your mouth.

■ Making Group Calls (Digital)

If a key has been programmed as **[Group]**, you can select a group ID from the list to make a call to those parties on a Conventional channel.

To select a group ID:

- 1 Press the key programmed as **[Group]**.
- 2 Press the \wedge/\vee key to select a group ID/name from the list.
- 3 Press and hold the **PTT** switch to make the call.
 - Speak into the transceiver as you would during a normal transmission.

■ Making Individual Calls (Digital)

If a key has been programmed with **[Individual]**, you can make calls to specific persons.

- 1 Press the key programmed as **[Individual]**.
- 2 Press the \wedge/\vee key to select a unit ID from the list.
 - When using a microphone DTMF keypad, you can enter a unit ID directly.
- 3 Press and hold the **PTT** switch to make the call.
 - Speak into the transceiver as you would during a normal transmission.

RECEIVING

Select the desired zone and channel. If signaling has been programmed on the selected channel, you will hear a call only if the received signal matches your transceiver settings.

Note: Signaling allows your transceiver to code your calls. This will prevent you from listening to unwanted calls. Refer to "SIGNALING" on page 16 for details.

■ Receiving Group Calls (Digital)

When you receive a group call on a Conventional channel and the received group ID matches the ID set up on your transceiver, you can hear the caller's voice.

When you receive a group call on a Trunking channel, the transceiver automatically switches to the communications channel to receive the call.

■ Receiving Individual Calls (Digital)

When you receive an individual call, a ringing tone will sound and the caller's ID will appear on the display. To respond to the call, press and hold the **PTT** switch and speak into the transceiver as you would during a normal transmission.

SCAN

Scan monitors for signals on the transceiver channels. While scanning, the transceiver checks for a signal on each channel and only stops if a signal is present.

To begin scanning, press the key programmed as **[Scan]**.

- The ↻ indicator appears.
- When a signal is detected on a channel, Scan pauses at that channel. The transceiver will remain on the busy channel until the signal is no longer present, at which time Scan resumes.

To stop scanning, press the **[Scan]** key again.

Note: To use Scan, there must be at least 2 channels in the scan sequence.

TEMPORARY CHANNEL LOCKOUT

During scan, you can temporarily remove specific channels from the scanning sequence by selecting them and pressing the key programmed as **[Scan Delete/Add]**.

- The channel is no longer scanned. However, when scanning is ended and restarted, the channels are reset and deleted channels will again be in the scanning sequence.

PRIORITY SCAN

If a Priority channel has been programmed, the transceiver will automatically change to the Priority channel when a call is received on that channel, even if a call is being received on a normal channel.

- The  indicator appears when the selected channel is the Priority channel (depending on dealer setting).



SCAN REVERT

The Scan Revert channel is the channel selected when you press the **PTT** switch to transmit during scan. Your dealer can program one of the following types of Scan Revert channels:

- **Selected:** The last channel selected before scan.
- **Selected + Talkback:** Same as “Selected”, plus you can respond to calls on the channel at which scan is paused.
- **Priority:** The Priority channel.
- **Priority + Talkback:** Same as “Priority”, plus you can respond to calls on the channel at which scan is paused.
- **Last Called + Selected:** The last channel on which you receive a call.

SCAN DELETE/ADD

You can add and remove zones and/or channels/group IDs to and from your scan list.

- 1 Select your desired zone and/or channel/group ID.
- 2 Press the key programmed as **[Zone Delete/Add]** (to add/remove zones) or **[Scan Delete/Add]** (to add/remove channels/group IDs).
 - You can also press and hold the key programmed as **[Scan Delete/Add]** to add/remove zones.
 - When a channel/Group ID is added to scan, the  icon appears on the display.
 - When a zone is added to scan, the  icon appears on the display.

FleetSync: ALPHANUMERIC 2-WAY PAGING FUNCTION

FleetSync is an Alphanumeric 2-way Paging Function, and is a protocol owned by **JVC KENWOOD Corporation**.

Note: This function is available only in analog operation.

SELCALL (SELECTIVE CALLING)

A Selcall is a voice call to a station or group of stations.

■ Transmitting

- 1 Select your desired zone and channel.
- 2 Press the key programmed as **[Selcall]** to enter Selcall mode.
- 3 Press the \wedge/\simeq key to select the station you want to call.
- 4 Press the **PTT** switch and begin your conversation.

■ Receiving

An alert tone will sound and the transceiver will enter Selcall mode. The calling station's ID will appear when a Selcall is received. You can respond to the call by pressing the **PTT** switch and speaking into the microphone.

■ Identification Codes

An ID code is a combination of a 3-digit Fleet number and a 4-digit ID number. Each transceiver has its own ID.

- Enter a Fleet number (100 ~ 349) to make a group call.
- Enter an ID number (1000 ~ 4999) to make an individual call in your fleet.
- Enter a Fleet number to make a call to all units in the selected fleet (Fleet call).

STATUS MESSAGE

You can send and receive 2-digit Status messages which may be decided in your talk group. Messages can contain up to 16 alphanumeric characters. Status messages range from 10 to 99 (80 ~ 99 are reserved for special messages).

A maximum of 15 received messages (combined status messages and short messages) can be stored in the stack memory of your transceiver.

■ Transmitting

- 1 Select your desired zone and channel.
- 2 Press the key programmed as **[Status]** to enter Status mode (proceed to step 5) or **[Selcall + Status]** to enter Selcall mode (proceed to step 3).
- 3 Press the \wedge/\simeq key to select the station you want to call.
 - If Manual Dialing is enabled, you can enter a station ID by using the microphone DTMF keypad by pressing and holding the **S** or ***X** key. Repeat this process until the entire ID is entered.
- 4 Press the **S** or ***X** key to enter Status mode.

- 5 Press the \wedge/\surd key to select the status you want to transmit.
 - If Manual Dialing is enabled, you can enter a station ID by using the microphone DTMF keypad (refer to step 3, above).
- 6 Press the **PTT** switch to initiate the call.
 - “COMPLETE” appears on the display when the status has been successfully transmitted.

■ Receiving

A calling ID or text message will appear when a Status call is received. Press any key to return to normal operation.

■ Reviewing Messages in the Stack Memory

- 1 Press the key programmed as **[Stack]**, or press and hold the key programmed as **[Selcall]**, **[Status]**, or **[Selcall + Status]** to enter Stack mode.
 - The last received message is displayed.
- 2 Press the \wedge/\surd key to select the desired message.
 - Message types are identified as follows:
ID: Caller ID, ST: Status Message, ME: Short Message
 - Press and hold the **S** or ***** key for 1 second to cycle the display information as follows:
ID Name > Status/Short Message > CH/GID
- 3 Press the \blacktriangle key to return to normal operation.
 - To delete the selected message, press the **A** or **#** key. To confirm the deletion, Press the **S** or ***** key.
 - To delete all messages, press and hold the **A** or **#** key for 1 second. To confirm the deletion, Press the **S** or ***** key.

SHORT MESSAGES

This transceiver can receive short data messages which contain a maximum of 48 characters.

- Received short messages are displayed the same as Status messages. A maximum of 15 received messages (combined status messages and short messages) can be stored in the stack memory of your transceiver.

GPS REPORT

GPS data can be manually transmitted by pressing the key programmed as **[Send the GPS data]**. If set up by your dealer, GPS data may be automatically transmitted at a preset time interval.

- When using the NX-720G/ NX-820G, you must connect a KRA-40 GPS antenna.
- When using the NX-720/ NX-820, you must connect an external GPS unit.
- When the power is turned ON and/or the reception condition of the GPS satellite is poor, positioning completion time may take longer.

5-TONE SIGNALING

5-tone Signaling is enabled or disabled by your dealer. This function opens the squelch only when the transceiver receives the 5 tones programmed in your transceiver. Transceivers that do not transmit the correct tones will not be heard.

SELCALL (SELECTIVE CALLING)

A Selcall is a voice call to a station or group of stations.

■ Transmitting

- 1 Select your desired zone and channel.
- 2 Press the key programmed as **[Selcall]** to enter Selcall mode.
- 3 Press the \wedge/\vee key to select the station you want to call.
 - When using a microphone DTMF keypad, you can directly enter the station ID.
- 4 Press the key programmed as **[Call 1]** to **[Call 6]** and begin your conversation.

Note: Additionally, you can also use the keys programmed as **[Digit 1x Down]**, **[Digit 1x Up]**, **[Digit 10x Down]**, and **[Digit 10x Up]** to adjust the Selcall number. **[Digit 1x Up/Down]** increases/decreases the Selcall number by 1 each time the key is pressed. **[Digit 10x Up/Down]** increases/decreases the Selcall number by 10 each time the key is pressed

■ Receiving

When you receive a call containing the correct tones, the transceiver will enter Selcall mode. An alert tone will sound and the calling station's ID appears on the display. Press any key to return to normal operation.

STATUS MESSAGE

You can send and receive Status messages which may be decided in your talk group. Messages can contain up to 16 alphanumeric characters.

A maximum of 15 received messages can be stored in the stack memory of your transceiver.

■ Transmitting

- 1 Select your desired zone and channel.
- 2 Press the key programmed as **[Status]** to enter Status mode (proceed to step 5) or **[Selcall + Status]** to enter Selcall mode (proceed to step 3).
- 3 Press the \wedge/\vee key to select the station you want to call.
 - In Selcall List Mode, press and hold the **S** or **✱** key for 1 second to enter Manual Input mode. Press the \wedge/\vee key to select the digit you want to change, then rotate the Selector to change the Code Up or Down. Or, you can enter the Code directly by using the microphone DTMF keypad.
- 4 Press the **S** or **✱** key to enter Status mode.
- 5 Press the \wedge/\vee key to select the status you want to transmit.

- In Selcall List Mode, press and hold the **S** or ***** key for 1 second to enter Manual Input mode. Press the **↕** key to select the digit you want to change, then rotate the Selector to change the Code Up or Down. Or, you can enter the Code directly by using the microphone DTMF keypad.

6 Press the key programmed as **[Call 1]** to **[Call 6]** to initiate the call.

■ **Receiving**

A calling ID or text message will appear when a Status call is received. Press any key to return to normal operation.

DTMF (DUAL TONE MULTI FREQUENCY) CALLS

MANUAL DIALING

- 1 Press and hold the **PTT** switch.
- 2 Enter the desired digits using the microphone DTMF keypad.
 - If you release the **PTT** switch, transmit mode will end even if the complete number has not been sent.
 - If the Keypad Auto **PTT** function has been enabled by your dealer, you do not need to press the **PTT** switch to transmit; you can make the call simply by pressing the microphone DTMF keys.

■ Store & Send

- 1 Press the key programmed as **[Autodial]**.
- 2 Enter up to 30 digits using the microphone DTMF keypad.
- 3 Press the **PTT** switch to make the call.

AUTODIAL

Autodial allows you to quickly call DTMF numbers that have been programmed onto your transceiver.

- 1 Press the key programmed as **[Autodial]**.
 - The first entry in the Autodial list appears on the display.
- 2 Press the \wedge/\surd key to select an autodial list number.
 - You can also enter a number from 01 ~ 32 directly using the microphone DTMF keypad.
- 3 Press the **PTT** switch to make the call.

■ Storing an Autodial Entry

- 1 Press the key programmed as **[Autodial Programming]**.
- 2 Press the \wedge/\surd key to select a memory location number.
- 3 Press the **S** or \times key to enter a name for the list number.
- 4 Press the \wedge/\surd key to select a digit.
- 5 Press the **C>** key to accept the entered digit and move the cursor to the right.
 - Press the **A** or **#** key to delete an incorrect digit. Press and hold the **A** or **#** key to delete all digits.
- 6 Repeat steps 4 and 5 to enter the entire name.
- 7 Press the **S** or \times key to accept the name and enter a number.
- 8 Press the \wedge/\surd key to select a digit.
 - You can also enter digits directly using the microphone DTMF keypad.
- 9 Press the **S** or \times key to accept the entered digit.
 - Press the **A** or **#** key to delete an incorrect digit. Press and hold the **A** or **#** key to delete all digits.
- 10 Repeat steps 8 and 9 to enter the entire number.

11 Press the **S** or **✖** key to accept the number and store the entry.

■ Removing an Autodial Entry

- 1 Press the key programmed as **[Autodial Programming]**.
- 2 Press the **^/∨** key to select a memory location number.
- 3 Press the **A** or **#** key.
 - “DELETE” appears on the display.
 - Additionally, you can press and hold the **A** or **#** key to delete all entries.
- 4 Press the **S** or **✖** key key to confirm the deletion.

REDIALING

- 1 Press the key programmed as **[Autodial]**.
- 2 Press the **✖** key, then press the **0** key.
 - If there is no data in the redial memory, an error tone will sound.
- 3 Press the **PTT** switch to make the call.

STUN

This function is used when a transceiver is stolen or lost. When the transceiver receives a call containing a stun code, the transceiver becomes disabled. The stun code is cancelled when the transceiver receives a call with a revive code.

- “STUN” appears on the display while the transceiver is stunned.

ADVANCED OPERATIONS

EMERGENCY CALLS

If your transceiver has been programmed with the Emergency function, you can make emergency calls.

- 1 Press and hold the key programmed as **[Emergency]**.
 - Ask your dealer for the length of time necessary to hold this key before the transceiver enters Emergency mode.
 - When the transceiver enters Emergency mode, it will change to the Emergency channel and begin transmitting based on how it is set up by your dealer.
- 2 To exit Emergency mode, press the **[Emergency]** key again.
 - If the Emergency mode completes a preset number of cycles, Emergency mode will automatically end and the transceiver will return to the zone and channel that was in use before Emergency mode was entered.

Note:

- ◆ Your dealer can set the transceiver to emit a tone when transmitting in Emergency mode.
 - ◆ Your dealer can set the transceiver to emit tones and received signals as normal, or mute the speaker during Emergency operation.
-

SCRAMBLER (ANALOG) / ENCRYPTION (DIGITAL)

■ Secure (Encrypted) Transmission

Press the key programmed as **[Scrambler/ Encryption]** to switch the transceiver to secure (encrypted) transmission.

- The \diamond icon appears on the display.
- Pressing the **PTT** switch after the Scrambler or Encryption function has been turned ON encrypts the transmitted signal.

■ Selecting the Scrambler Code or Encryption Key

- 1 Press the key programmed as **[Scrambler/ Encryption Code]** to enter Code or Key Selection mode.
- 2 Press the \wedge/\vee key to increase or decrease the code or key.
 - There are 16 available Scrambler codes or Encryption keys (1 ~ 16).

Note: This function cannot be used in certain countries. Contact your **KENWOOD** dealer for further information.

SIGNALING

■ Quiet Talk (QT)/ Digital Quiet Talk (DQT)

Your dealer may have programmed QT or DQT signaling on your transceiver channels. A QT tone/ DQT code is a sub-audible tone/code which allows you to ignore (not hear) calls from other parties who are using the same channel.

Operator Selectable Tone (OST)

If a key has been programmed with **[OST]**, you can reprogram the QT/DQT settings on each of your channels.

- 1 Select your desired channel.
- 2 Press and hold the key programmed as **[OST]** for 1 second.
- 3 Press the  key to select your desired tone or code.
 - Your dealer can set up to 40 tones/codes.
- 4 When you have finished operating using OST, press the **[OST]** key again to turn the OST function OFF.

■ Radio Access Number (RAN)

RAN is a new signaling system designed for digital radio communications.

When a channel is set up with a RAN, squelch will only open when a call containing a matching RAN is received. If a call containing a different RAN is made on the same channel you are using, you will not hear the call. This allows you to ignore (not hear) calls from other parties who are using the same channel.

■ Optional Signaling

Your dealer may also program several types of optional signaling for your transceiver channels.

5-tone Signaling: Refer to “SELCALL (SELECTIVE CALLING)” on page 12.

DTMF Signaling: DTMF Signaling opens the squelch only when the transceiver receives a call containing a matching DTMF code.

FleetSync Signaling: Refer to “SELCALL (SELECTIVE CALLING)” on page 10.

NXDN ID Signaling: NXDN ID is an optional signaling system available only for digital communications.

MONITOR/ SQUELCH OFF

You can use the key programmed as **[Monitor]** or **[Squelch Off]** to listen to weak signals that you cannot hear during normal operation and to adjust the volume when no signals are present on your selected channel.

- The  icon appears on the display while Monitor or Squelch Off is activated.



Your dealer can program a key with one of four Monitor/Squelch Off functions:

- **Monitor:** Press to deactivate QT, DQT, DTMF, 5-tone, or FleetSync Signaling. Press again to return to normal operation.
- **Monitor Momentary:** Press and hold to deactivate QT, DQT, DTMF, 5-tone or FleetSync Signaling. Release to return to normal operation.
- **Squelch Off:** Press to hear background noise. Press again to return to normal operation.
- **Squelch Off Momentary:** Press and hold to hear background noise. Release to return to normal operation.

■ Squelch Level

If a key has been programmed as **[Squelch Level]**, you can readjust your transceiver's squelch level:

- 1 Press the key programmed as **[Squelch Level]**.
 - The current squelch level appears on the display.

- 2 Press the  key to select your desired squelch level from 0 to 9.
- 3 Press the **S** or  key to store the new setting.

SIGNAL STRENGTH INDICATOR

The signal strength indicator displays the strength of received calls. No icon appears when no signal is available.



Strong



Sufficient



Weak



Very weak

 flashes when out of range (NXDN Trunking only).

PUBLIC ADDRESS (PA)

The PA system can only be used with an external speaker.

- 1 Press the key programmed as **[Public Address]** to activate the Public Address function.
 - The  icon appears on the display.
- 2 Press and hold the **PTT** switch, then speak into the microphone to make your address through the external speaker.
- 3 Press the **[Public Address]** key again to exit Public Address.

HORN ALERT

When a call is received that matches the optional signaling set up on your transceiver, Horn Alert causes the vehicle horn or some other external alert to sound. This function notifies you of a received call when you are away from your vehicle.

To toggle Horn Alert ON and OFF, press the key programmed as **[Horn Alert]**.

- The  icon momentarily appears on the display when Horn Alert is active.

EXTERNAL SPEAKER

When attaching an external speaker to the transceiver via the KCT-60, press the key programmed as **[External Speaker]** to output all received signals through the external speaker.

- The  icon appears on the display.

Press the **[External Speaker]** key again to output all received signals only through the built-in speaker.

DISPLAY BRIGHTNESS

You can cycle the display brightness between high, low, and off by pressing the key programmed as **[LCD Brightness]**.



BACKGROUND OPERATIONS

TIME-OUT TIMER (TOT)

The Time-out Timer prevents you from using a channel for an extended duration. If you continuously transmit for a preset time, the transceiver will stop transmitting and an alert tone will sound. Release the **PTT** switch.

AUXILIARY PORT

Press the key programmed as **[AUX A]** or **[AUX B]** to activate the auxiliary port. The auxiliary port is used with external devices.

- The  icon appears on the display when the auxiliary A port is active.
- The  icon appears on the display when the auxiliary B port is active.

BUSY CHANNEL LOCKOUT (BCL)

If BCL is set up by your dealer, you will be unable to transmit if the channel is already in use.

- “BUSY” appears on the display when you press the **PTT** switch. Use a different channel or wait until the channel becomes free.

If your dealer has programmed BCL Override for your transceiver, you can override the BCL by pressing the **PTT** switch again, immediately after releasing it, when the channel is busy.

CONTROL CHANNEL HUNT

On digital Trunking channels, the transceiver automatically searches for a control channel.

- While searching for a control channel, the antenna icon will flash and no signals can be received.

PTT ID

PTT ID is the transceiver unique ID code which is sent each time the **PTT** switch is pressed and/or released. (PTT ID can be made only in analog operation.)

COMPANDER

If programmed by your dealer for a channel, the compander will remove excessive noise from transmitted signals, providing higher clarity of signals. (The compander is used only in analog operation.)

- Your dealer must set the compander for both the transmit side and the receive side in order for the compander to operate.

TRANSMIT POWER

Your dealer has programmed a transmit power level for each channel. Power levels can be high or low.